

ALKON[®]

MATERIAL HANDLING & OFFICE PRODUCTS



MATERIAL HANDLING BINS



CAT.- 2011-A



SB-7

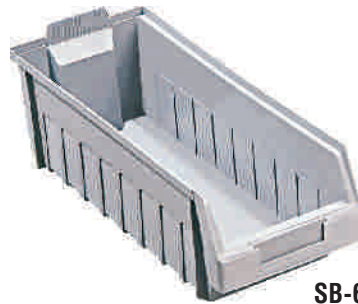

SB-6



SB-5



SB-4



SB-3



SB-2



SB-1

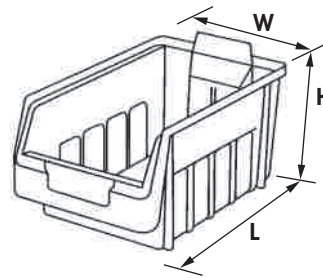

MADE FROM POLYPROPYLENE COPOLYMER.

- ▶ Strong rear lip for use with louvre panels.
- ▶ Strong heavy duty reinforced base, sides & stacking rim.
- ▶ Resistance to most industrial solvents, withstands higher temperature.
- ▶ Clear access to contents.
- ▶ All bins with identification card holders.
- ▶ Incorporates a safety stop feature in SB - 4 / 5 / 6 at the back for use in shelves.



Supra bins are designed to stack one on top of each other.

Art No.	Outside Dimensions in mm			Inside Dimensions in mm		
	Length	Width	Height	Length	Width	Height
SB-1	125	100	60	117	80	52
SB-2	170	100	85	157	80	75
SB-3	220	130	125	200	115	115
SB-4	290	178	143	265	155	130
SB-5	290	363	145	265	340	130
SB-6	440	180	145	415	154	130
SB-7	435	400	215	405	360	208

All dimensions in mm approx.



Rear lip for easy access. Stops bin from coming out.

Colours : Red Blue Grey Green Yellow **(For SB-7 Red & Blue only)**

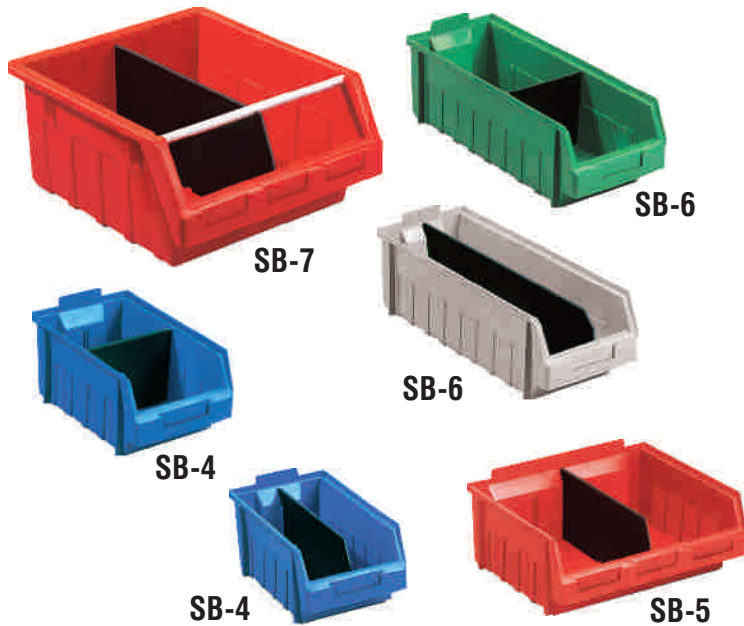

Supra Bins with Partitions

ALKON®

SUPRA BIN PARTITIONS

Other useful plastic accessories to match the Supra Bins range include Bin partitions.

Horizontal partition for SB4 & SB6

Art No.: SB4-6 HP

Vertical partition for SB4 & SB5

Art No.: SB4-5 VP

Vertical partition for SB6

Art No.: SB-6 VP

Vertical Partition for SB7

Art No.: SB-7 VP

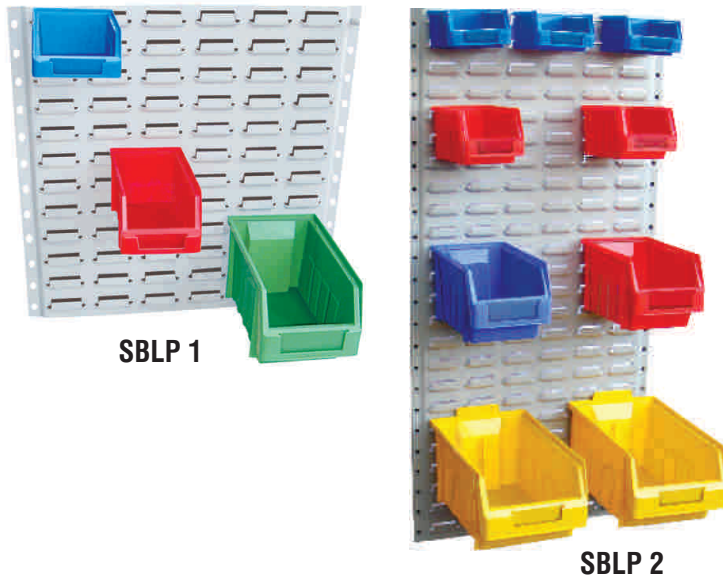

ALKON®

LOUVRE PANELS

The Louvre panels are made from powder coated 1.5 mm CRCA steel, and come in four sizes. These louvre panels can be easily fitted on walls or on a special stand provided.

Size of Louvre panel : Width X Height

Art No. SBLP1 : size 457 mm x 457 mm

Art No. SBLP2 : size 457 mm x 610 mm

Art No. SBLP3 : size 457 mm x 915 mm

Art No. SBLP6 : size 457 mm x 1830 mm

Colours : Light grey powder coated.

Number of Bins per Louvre panel

	SB1	SB2	SB3	SB4	SB5	SB6
LP 1	24	16	9	6	3	6
LP 2	32	20	12	8	4	8
LP 3	48	32	18	12	6	12
LP 6	96	64	36	24	12	24

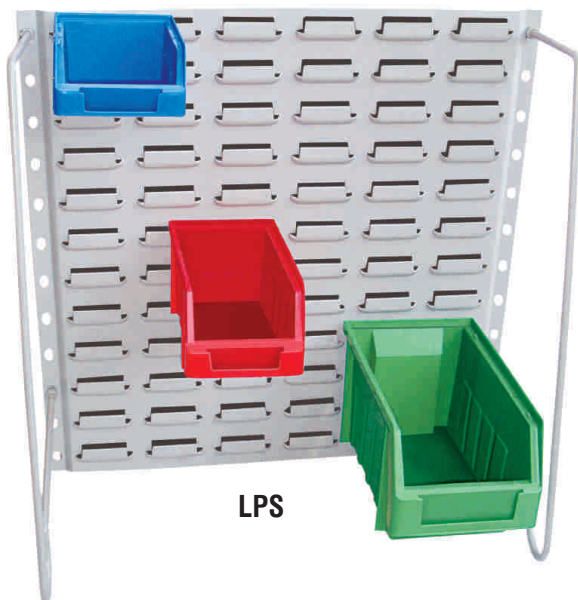

ALKON®

WIRE STAND

LP 1 Louvre Panel can be fitted on wire stand to hold bins & use on any table.

Art No.: LPS



FSS/L

ALKON[®]

LOUVRE PANEL STAND FSS/L

Free standing stand FSS/L can be fitted with two numbers of LP2 LOUVRE PANELS on each side. Order louvre panels and bins separately.

Art No.: FSS/L

DIMENSION : 457 X 630 X 1560 mm



FSS/L/2

ALKON[®]

LOUVRE PANEL STAND FSS/L/2

Free standing stand FSS/L/2 can be fitted with four numbers of LP2 LOUVRE PANELS on each side. Order louvre panels and bins separately.

Art No.: FSS/L/2

DIMENSION : 914 X 630 X 1560 mm



FSS/L/3

ALKON[®]

LOUVRE PANEL STAND FSS/L/3

Free standing stand FSS/L/3 can be fitted with six numbers of LP2 LOUVRE PANELS on each side. Order louvre panels and bins separately.

Art No.: FSS/L/3

DIMENSION : 1371 X 630 X 1560 mm



ALKON[®] **SHOP FLOOR TROLLEY**

Alkon Shop Floor Trolleys can be used single sided or double sided as per requirement. Ideal for component storage and transfer to assembly or production areas. Unit comprises of base unit with aluminium chequered top plate fitted with castors and a frame on which two louvre panels of size LP2 can be fitted on each side. Robust construction, Epoxy powder coated, easy assembly & has push pull handles on both sides.

Single sided trolley can hold 8 No's. SB1 Bins, 16 No's SB2 Bins, 6 No's SB3 Bins, 5 No's. SB4 Bins & extra bins on the bottom table top or different size of bins as per your requirement.

Overall Dimension :
L970 mm x B 600 mm x H 1100 mm.
Colour : Light Grey powder coated.

Trolley without louvre panels and Bins

Art No.: SFT

Order 2 No's SB LP2 for single side
and 4No's SB LP2 for double side separately.



ALKON[®] **SHOP FLOOR ROTARY STAND**

Alkon shop floor rotary stand has two tier system. Four louvre panels of size SB LP2 in each tier rotate on a thrust bearing. Easy rotation when loaded. Each tier rotates independently. Fully epoxy powder coated with sturdy steel base. Can hold different sizes of bins as per requirement. Rotary stand is supplied without louvre panels and Bins.

Order louvre panels and Bins separately

Dimension : Height 1420mm.

Diameter of rotation 1000mm

Art No.: SFRS-2

Colours : Light Grey powder coated.

ALKON RHINO TUFF BINS



New
ARTB-05

ARTB-10

ARTB-20

ARTB-30

ARTB-40

New
ARTB-25

ARTB-50

New
ARTB-60

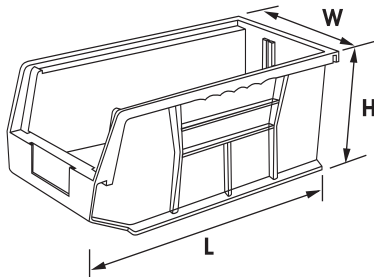

MADE FROM POLYPROPYLENE COPOLYMER.

- ▶ Strong ribs provided for optional dividers to increase storage options.
- ▶ Full length rear lip supports provided for hanging bins on louvre panels or rails.
- ▶ Reinforced ribs adds strength and avoids spreading.
- ▶ Extra wide stacking base for secure stacking.
- ▶ Extra wide label slot for easy content identification.
- ▶ Stopper prevents stacked bins from shifting forward.

Art No.	Outside Dimensions in mm			Inside Dimensions in mm		
	Length	Width	Height	Length	Width	Height
ARTB-05	109	104	49	95	89	43
ARTB-10	136	106	76	125	90	65
ARTB-20	187	106	76	171	90	65
ARTB-25	205	139	126	190	115	121
ARTB-30	274	140	127	256	115	115
ARTB-40	375	210	179	355	170	160
ARTB-50	457	280	255	432	241	240
ARTB-60	375	415	179	355	375	160

All dimensions in mm approx.

Colors for all Bins : **RED** **BLUE** **GREY** **GREEN** **YELLOW** (For ARTB-50 & ARTB-60 Red & Blue only)



RHINO 60

RHINO 30

RHINO 40

RHINO 50

RHINO 30 / RHINO 40 / RHINO 50 / RHINO 60 BINS
FITTED WITH VERTICAL DIVIDERS



RHINO 30 VERTICAL PARTITION

Vertical Partition for RHINO 30 bins. Available as an accessory to increase storage options

Art No.:- VP-ARTB 30

RHINO 40 / RHINO 60 VERTICAL PARTITION

Vertical Partition for RHINO 40 / RHINO 60 bins. Available as an accessory to increase storage options.

Art No.:- VP-ARTB 40 / 60

RHINO 50 VERTICAL PARTITION

Vertical Partition for RHINO 50 bins. Available as an accessory to increase storage options.

Art No.:- VP-ARTB 50

LOUVRE PANELS

Are manufactured from 1.5 mm CRCA steel and powder coated in grey color. RHINO BINS can be mounted with ease in variable combinations as listed Below.

Art No.	LOUVRE PANEL			
	LP 1	LP 2	LP 3	LP 6
SIZE	457 x 457	457 x 610	457 x 915	457 x 1830
ARTB-05	24	32	48	96
ARTB-10	24	32	48	96
ARTB-20	24	32	48	96
ARTB-25	9	12	18	36
ARTB-30	9	12	18	36
ARTB-40	4	6	8	18
ARTB-60	2	3	4	9

All dimensions in mm approx.

UNIVERSAL RAIL

Universal rail (SIZE 914 MM L X 75 MM H) made from steel and powder coated in grey color Can be mounted on any surface like walls, benches, slotted angle systems, stands, and trolleys. These rails increase the flexibility of using different sizes of bins with ease and help in optimizing Storage space.

Art No.:- AUR-1



RHINO BINS MOUNTED ON UNIVERSAL RAIL

DOUBLE SIDED STAND

Heavy duty double sided stand ideal for use with RHINO BINS in different combinations as detailed below. Please order RHINO BINS, Rails (AUR-1), Stands (ARSS-2) separately as per your requirements. Stand can be also used single side as per requirement.

ARSS-2 DIMENSION 1030 X 635 X 1450 mm.

ART NO.	BINS PERRAIL	RAILS PER ARSS		TOTAL NO. OF BINS
		Single Side	Double Side	
ARTB-05	8	15	-	120
ARTB-10	8	12	-	96
ARTB-20	8	12	-	96
ARTB-25	6	8	-	48
ARTB-30	6	8	-	48
ARTB-40	4	12	-	24
ARTB-60	2	12	-	12
ARTB-05	8	-	30	240
ARTB-10	8	-	24	192
ARTB-20	8	-	24	192
ARTB-25	6	-	16	96
ARTB-30	6	-	16	96
ARTB-40	4	-	24	48
ARTB-60	2	-	24	24



DOUBLE SIDED TROLLEY

Heavy duty double sided trolley base fitted with heavy duty castors. Ideal for use with Rhino bins in different combinations as required. Please order RHINO BINS, Rails (AUR-1) and ARSS-3 (Which consists of heavy duty trolley base ARSTM and Pipe set ARSP) separately.

ARSS-3 DIMENSION 1030 X 640 X 1620 mm.

(Width 1030 mm including handles on both sides)

ALKON HIPPO BINS



612-T



612-S



612-S2



612-M

MADE FROM POLYPROPYLENE COPOLYMER.

- ▶ Strong rear lip for use with louvred panels.
- ▶ Strong heavy duty with rounded base, sides & stacking rim.
- ▶ Resistant to most industrial solvents, withstands higher temperature.
- ▶ Can be stacked one on top of each other.
- ▶ Clear access to contents.
- ▶ All bins with identification card holders.
- ▶ Partitions available.
- ▶ Rounded Ergonomic Design to Give Extra Strength and Sturdiness for Storage

STACKING

Hippo bins are designed to stack one on top of each other.

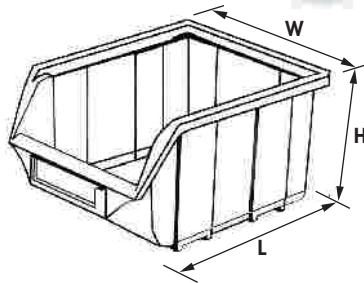

BIN PARTITIONS

Other useful plastic accessories to match the hippo bins range include bin partitions : Vertical partitions for (612-M, 612-DW, 612-B, 612-J)



ART NO.: 612-MVP



ART NO.: 612-BVP



ART NO.: 612-DWVP



ART NO.: 612-JVP

HIPPO BINS	Art No.	Outside Dimensions in mm			Inside Dimensions in mm		
		Length	Width	Height	Length	Width	Height
TINY	612T	100	110	53	80	90	43
SMALL	612S	150	110	75	130	90	68
SMALL	612S-2	175	115	75	150	90	64
MEDIUM	612M	250	165	125	225	132	115
DOUBLE WIDE	612DW	250	344	125	210	312	115
BIG	612T	355	220	150	330	182	138
JUMBO	612J	515	330	200	470	295	180

All dimensions in mm approx.

Colours : Red Blue Grey Green Yellow (For 612-J Red & Blue)



612-DW



612-B



612-J



LOUVRE PANELS

are manufactured from 1.5 mm CRCA steel and powder coated in grey color. Hippo bins can be mounted with ease in variable combination as listed below.

LOUVRE PANEL		NUMBER OF BINS					
ART NO.	DIMENSIONS IN MM	612-T	612-S	612-S2	612-M	612-DW	612-B
LP 1	457 x 457	24	24	24	6	3	4
LP 2	457 x 610	32	32	32	8	4	6
LP 3	457 x 915	48	48	48	12	6	10
LP 6	457 x 1830	96	96	96	24	12	20

UNIVERSAL RAIL

Universal rail (size 914 mm L x 75 mm H) made from steel and powder coated in Grey colour can be mounted on any surface like Walls, Benches, Slotted angle systems, Stands, and Trolleys. These rails increase the flexibility of using different sizes of bins with ease and help in optimizing storage space.

Art No.:- AUR-1

No of Bins per UNIVERSAL RAIL

ART NO.	612-T	612-S	612-S2	612-M	612-DW	612-B
NO. OF BINS	8	8	8	5	2	4



612-S HIPPO BINS MOUNTED ON UNIVERSAL RAIL

ALKON[®] HIPPO BIN RANGE

STANDS & CHANNELS

Free standing stand shown with Channels and bins.

Grey Powder coated.

Art No.: FSS/C

Order Bins & Channels Separately

STANDS & CHANNELS

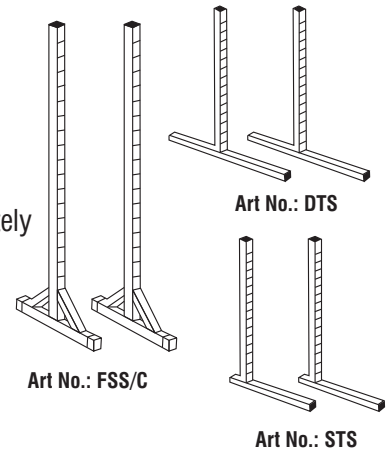

FSS/C



STS



DTS

ALKON[®] TABLE STANDS

SINGLE TABLE STAND

Art No.: STS

In single table stand three sizes of channels (2 of SC, 1 of MC & 1 of BC) can be fitted as shown in the picture
Grey Powder coated.



DOUBLE TABLE STAND

Art No.: DTS

In double table stand three sizes of channels small, medium and big can be fitted on both sides as shown in the picture

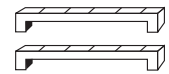

Art No.: WMS

Grey Powder coated.

Order Bins & Channels Separately

Dimension in mm	FSS	STS	DTS	WMS
W	665	665	665	665
H	1553	530	530	545
D	610	280	510	40

Type of Channels	Numbers of Channels per stand			
	FSS	STS	DTS	WMS
612 SC	12	5	10	5
612 MC	8	3	6	3
612 BC	7	3	6	3

Type of Channels	Size of Bins	No. of Bins per Channel
612 SC	612S	6
612 MC	612M	4
612 BC	612B	3

Length of all Channels is 665 mm.



FSS/L

ALKON[®]

◀ **LOUVRE PANEL STAND**

Free standing stand FSS/L can be fitted with two numbers of LP2 LOUVRE PANELS on each side. Order louvre panels and bins separately.

Art No.: FSS/L

DIMENSION : 457 X 630 X 1560 mm



FSS/L/2

ALKON[®]

LOUVRE PANEL STAND FSS/L/2 ▶

Free standing stand FSS/L/2 can be fitted with four numbers of LP2 LOUVRE PANELS on each side. Order louvre panels and bins separately.

Art No.: FSS/L/2

DIMENSION : 914 X 630 X 1560 mm



FSS/L/3

ALKON[®]

◀ **LOUVRE PANEL STAND FSS/L/3**

Free standing stand FSS/L/3 can be fitted with six numbers of LP2 LOUVRE PANELS on each side. Order louvre panels and bins separately.

Art No.: FSS/L/3

DIMENSION : 1371 X 630 X 1560 mm

DOUBLE SIDED STAND

Art No.: ARSS-2

Heavy duty double sided stand ideal for use with Hippo bins in different combinations as detailed below. Please order Hippo bins, Rails (AUR-1), Stands (ARSS-2) separately as per your requirement.

Stand can be also used single side as per requirement.

ARSS-2 DIMENSION 1030 X 635 X 1450 mm.



ART NO.	BINS PER RAIL	RAILS PER ARSS		TOTAL NO. OF BINS
		Single Side	Double Side	
612-T	8	15	-	120
612-S	8	12	-	96
612-S2	8	12	-	96
612-M	5	9	-	45
612-DW	2	9	-	18
612-B	4	14	-	28
612-T	8	-	30	240
612-S	8	-	24	192
612-S2	8	-	24	192
612-M	5	-	18	90
612-DW	2	-	18	36
612-B	4	-	28	56

DOUBLE SIDED TROLLEY

Art No.: ARSS-3

Heavy duty double sided trolley base fitted with heavy duty castors. Ideal for use with Hippo bins in different combinations as required. Please order HIPPO BINS, Rails (AUR-1) and ARSS-3 (It consists of heavy duty trolley base ARSTM and Pipe set ARSP) separately.

ARSS-3 DIMENSION 1030 X 640 X 1620 mm.

(Width 1030 mm including Handles on both sides)



ALKON TOTE BINS



AK-421



AK-422

MADE FROM POLYPROPYLENE COPOLYMER.

- ▶ Stable and robust Design.
- ▶ Flexible use due to Vertical and Horizontal partitions (optional).
- ▶ Compatible with shelving and vertical storage systems.
- ▶ Large Label Holder.
- ▶ Smooth Internal wall for easy cleaning.
- ▶ Anti skid bottom.
- ▶ Stackable.

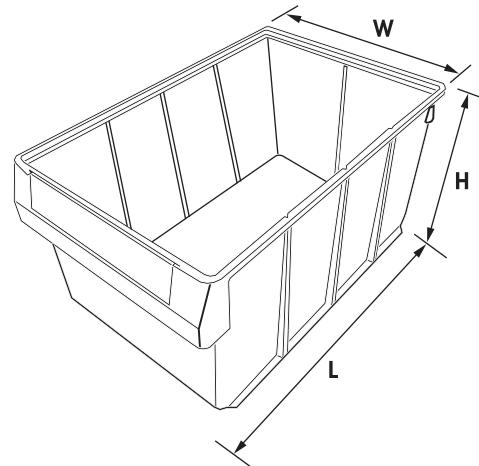

Art No.	Outside Dimensions in mm			Inside Dimensions in mm		
	LENGTH	WIDTH	HEIGHT	LENGTH	WIDTH	HEIGHT
AK-421	400	255	100	365	230	90
AK-422	400	255	200	365	230	190

All dimensions in mm approx.

BIN PARTITIONS

DIVIDERS FOR AK-421	ART NO.
Horizontal Plain Divider	AK-421-HP
Horizontal With Single Slot	AK-421-HP S1
Vertical With Three Slot	AK-421-VP S3

BIN PARTITIONS

DIVIDERS FOR AK-422	ART NO.
Horizontal Divider	AK-422-HP



AK-421
Horizontal Dividers.



AK-421
Horizontal & Vertical Dividers.



AK-422
Horizontal divider.

Colours : RED BLUE

ALKON BULL BINS



BULL BIN 5



BULL BIN 15



BULL BIN 25



BULL BIN 35

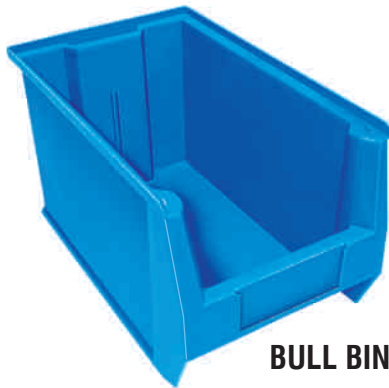

BULL BIN 45

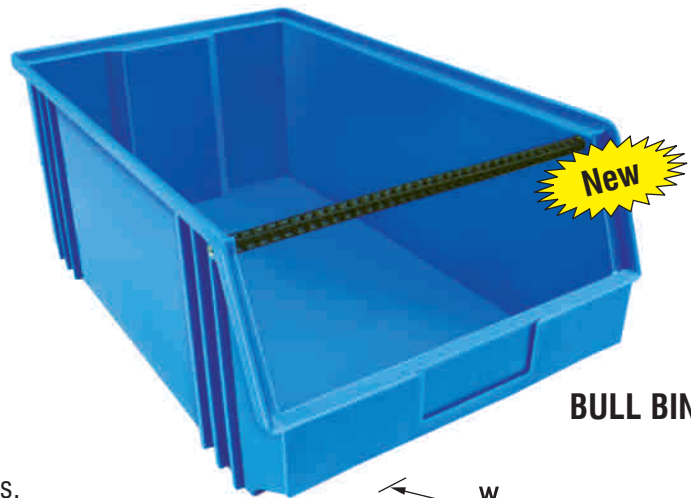

BULL BIN 55

MADE FROM POLYPROPYLENE COPOLYMER.

- ▶ Provision for vertical dividers to increase storage options.
- ▶ Full length rear lip supports provided for hanging bins on louvered panels or rails.
- ▶ Anti skid strips provided at the base.
- ▶ Extra wide stacking base for secure stacking.
- ▶ Tapered front & rear bottom for easy movement on conveyers.
- ▶ Stopper prevents stacked bins from shifting forward.
- ▶ Extra wide label slot for easy content identification.

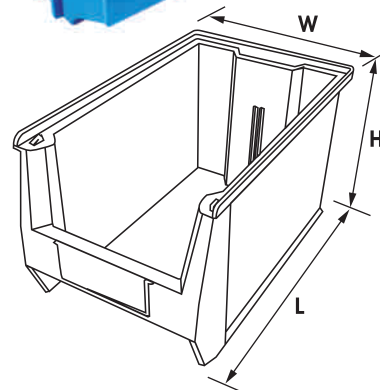

ART NO.	OUTSIDE DIMENSIONS IN MM			INSIDE DIMENSIONS IN MM		
	Length	Width	Height	Length	Width	Height
BULL BIN 5	168	102	74	145	86	66
BULL BIN 15	201	125	101	178	105	92
BULL BIN 25	229	150	126	192	128	114
BULL BIN 35	300	208	158	255	185	145
BULL BIN 45	348	210	200	305	187	185
BULL BIN 55	510	310	200	480	280	195

All Dimension in mm Approx.

Colors for all Bins : Red Blue Grey Green Yellow
 (Bull Bin 55 - Red & Blue colour only)

ALKON[®]

BIN PARTITIONS

Vertical Partition for BULL BINS. Available as an accessory to increase storage options

BULL BIN 25 VERTICAL PARTITION

Art No.: BULL BIN 25 VP

BULL BIN 35 VERTICAL PARTITION

Art No.: BULL BIN 35 VP

BULL BIN 45 VERTICAL PARTITION

Art No.: BULL BIN 45 VP

LOUVRE PANELS

are manufactured from 1.5 mm CRCA steel and powder coated in grey color. BULL BINS can be mounted with ease in variable combinations as listed Below.

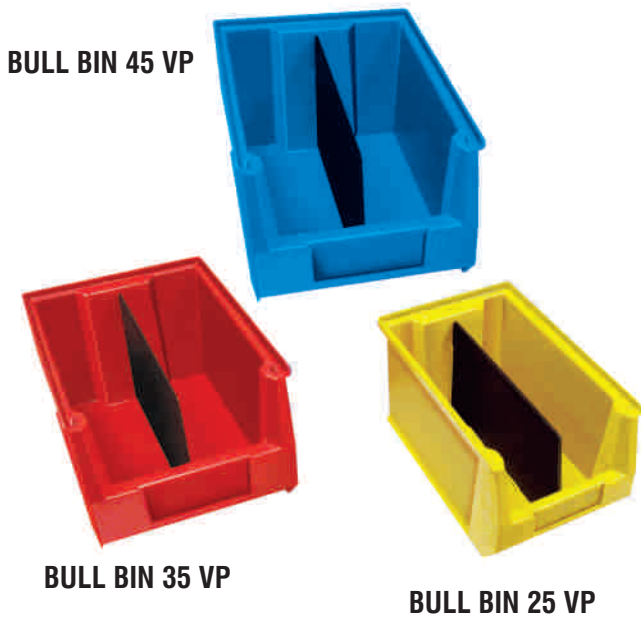

LOUVRE PANEL		NUMBER OF BINS				
ART NO.	SIZE	BULL BIN 5	BULL BIN 15	BULL BIN 25	BULL BIN 35	BULL BIN 45
LP 1	457 x 457	24	12	9	4	4
LP 2	457 x 610	36	15	12	6	6
LP 3	457 x 915	48	24	18	10	8
LP 6	457 x 1830	96	48	36	20	16

All Dimensions in mm

UNIVERSAL RAIL

Universal rail (SIZE 914 MM L X 75 MM H) made from steel and powder coated in grey color Can be mounted on any surface like walls, benches, slotted angle systems, stands, and trolleys. These rails increase the flexibility of using different sizes of bins with ease and help in optimizing Storage space.

Art No.: AUR-1

No of Bins per UNIVERSAL RAIL

ART NO.	BULL BIN 5	BULL BIN 15	BULL BIN 25	BULL BIN 35	BULL BIN 45
NO. OF BINS	9	7	6	4	4

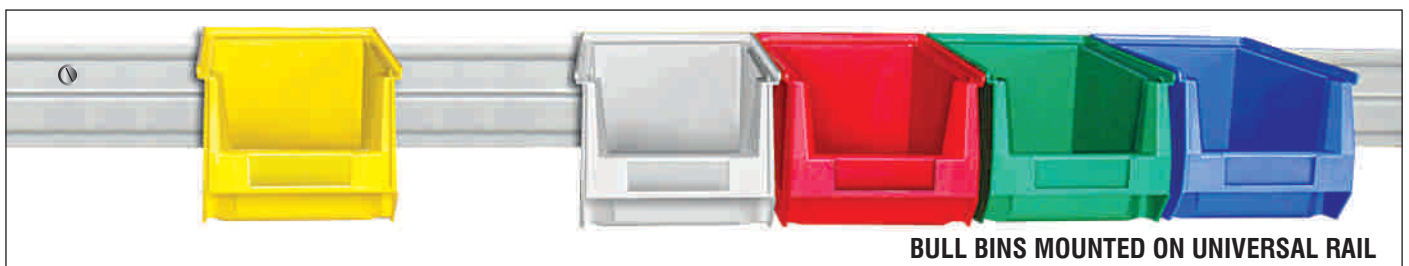

DOUBLE SIDED STAND

Heavy duty double sided stand is ideal for use with BULL BINS in different combinations as detailed below. Please order BULL BINS, Rails (AUR-1), Stands (ARSS-2) separately as per your requirement. Stand can be also used single sided as per requirement.

ARSS-2 DIMENSION 1030 X 635 X 1450 mm.



ART NO.	BINS PERRAIL	RAILS PER ARSS		TOTAL NO. OF BINS
		Single Side	Double Side	
BULL BIN 5	9	12	-	135
BULL BIN 15	7	10	-	77
BULL BIN 25	6	9	-	54
BULL BIN 35	4	14	-	28
BULL BIN 45	4	10	-	20
BULL BIN 5	9	-	24	270
BULL BIN 15	7	-	20	154
BULL BIN 25	6	-	18	108
BULL BIN 35	4	-	28	56
BULL BIN 45	4	-	20	40

DOUBLE SIDED TROLLEY

Heavy duty double sided trolley base fitted with heavy duty castors. Ideal for use with Bull bins in different combinations as required. Please order BULL BINS, Rails (AUR-1) and ARSS-3 (It consists of heavy duty trolley base ARSTM and Pipe set ARSP) separately.

ARSS-3 DIMENSION 1030 X 640 X 1620 mm.
(1030 mm including handles on both sides)





FSS/L

ALKON[®]

◀ **LOUVRE PANEL STAND FSS/L**

Free standing stand FSS/L can be fitted with two numbers of LP2 LOUVRE PANELS on each side. Order louvre panels and bins separately.

ART NO.: FSS/L

DIMENSION : 457 X 630 X 1560 mm

ALKON[®]

LOUVRE PANEL STAND FSS/L/2 ▶

Free standing stand FSS/L/2 can be fitted with four numbers of LP2 LOUVRE PANELS on each side. Order louvre panels and bins separately.

ART NO.: FSS/L/2

DIMENSION : 914 X 630 X 1560 mm



FSS/L/2



FSS/L/3

ALKON[®]

◀ **LOUVRE PANEL STAND FSS/L/3**

Free standing stand FSS/L/3 can be fitted with six numbers of LP2 LOUVRE PANELS on each side. Order louvre panels and bins separately.

ART NO.: FSS/L/3

DIMENSION : 1371 X 630 X 1560 mm



SUPRA BINS



RHINO BINS



HIPPO BINS



BULL BINS

BINS	SR NO.	ART NO.	OUTER DIMENSIONS			INNER DIMENSIONS			EFFECTIVE HEIGHT	STD. PACK
			Length	Width	Height	Length	Width	Height		
SUPRA BINS	1.	SB-1	125	100	60	117	80	52	25	50
	2.	SB-2	170	100	85	157	80	75	40	50
	3.	SB-3	220	130	125	200	115	115	73	50
	4.	SB-4	290	178	143	265	155	130	80	10
	5.	SB-5	290	363	145	265	340	130	83	5
	6.	SB-6	440	180	145	415	154	130	85	10
	7.	SB-7	435	400	215	405	360	208	120	6
RHINO BINS	NEW 8.	ARTB-05	109	104	49	95	89	43	23	50
	9.	ARTB-10	136	106	76	125	90	65	28	50
	10.	ARTB-20	187	106	76	171	90	65	32	40
	NEW 11.	ARTB-25	205	139	126	190	115	121	61	40
	12.	ARTB-30	274	140	127	256	115	115	56	40
	13.	ARTB-40	375	210	179	355	170	160	80	10
	14.	ARTB-50	457	280	255	432	241	240	108	6
	NEW 15.	ARTB-60	375	415	179	355	375	160	80	5
HIPPO BINS	16.	612-T	100	110	53	80	90	43	25	60
	17.	612-S	150	110	75	130	90	68	40	50
	18.	612-S2	175	115	75	150	90	64	40	40
	19.	612-M	250	165	125	225	132	115	67	40
	20.	612-DW	250	344	125	210	312	115	67	20
	21.	612-B	355	220	150	330	182	138	85	10
	22.	612-J	515	330	200	470	295	180	115	8
BULL BINS	23.	BULL BIN-5	168	102	74	145	86	66	38	50
	24.	BULL BIN-15	201	125	101	178	105	92	48	40
	25.	BULL BIN-25	229	150	126	192	128	114	58	50
	26.	BULL BIN-35	300	208	158	255	185	145	80	20
	27.	BULL BIN-45	348	210	200	305	187	185	110	10
	NEW 28.	BULL BIN-55	510	310	200	480	280	195	85	8



TOTE BINS



PANDA SHELF BINS



KOALA PICK BINS

BINS	SR NO.	ART NO.	OUTER DIMENSIONS			INNER DIMENSIONS			EFFECTIVE HEIGHT	STD. PACK
			Length	Width	Height	Length	Width	Height		
TOTE BINS	29.	AK-421	400	255	100	365	230	90	90	10
	30.	AK-422	400	255	200	365	230	190	190	5
PANDA SHELF BINS	NEW 31.	PSB-301	315	100	60	293	86	55	55	24
	32.	PSB-302	315	100	110	293	86	105	105	24
	NEW 33.	PSB-303	315	150	110	293	136	105	105	12
	NEW 34.	PSB-304	315	220	135	293	210	130	130	12
	NEW 35.	PSB-305	315	300	135	293	282	130	130	6
	36.	PSB-401	415	100	60	393	86	55	55	24
	37.	PSB-402	415	100	110	393	86	105	105	24
	38.	PSB-403	415	150	110	393	136	105	105	12
	39.	PSB-404	415	220	135	393	210	130	130	12
	40.	PSB-405	415	300	135	393	282	130	130	6
	41.	PSB-602	615	100	110	593	86	105	105	12
	42.	PSB-603	615	150	110	593	136	105	105	12
KOALA PICK BINS	NEW 43.	AKP-01	130	105	60	105	90	55	26	64
	NEW 44.	AKP-11	180	105	90	155	90	85	42	52
	NEW 45.	AKP-22	220	140	140	195	125	135	65	24
	NEW 46.	AKP-32	300	140	140	270	125	135	65	24
	NEW 47.	AKP-33	300	215	140	270	200	135	65	16
	NEW 48.	AKP-35	300	435	140	270	410	135	65	8
	NEW 49.	AKP-42	400	145	200	360	125	195	95	21
	NEW 50.	AKP-43	400	215	200	360	200	195	95	14

All dimensions in mm Approx



Colours for Bins : RED ■ BLUE ■ GREY ■ GREEN ■ YELLOW ■

For SB-7, ARTB-50, ARTB-60, 612-J, AK-421, AK-422, BULL BIN-55 only Red & Blue colours.

For Panda Shelf Bins & Koala Pick Bins only Blue colour.

ALKON BINS PER LOUVRE / SINGLE OR DOUBLE SIDED ARSS STANDS

ART NO.	LOUVRE PANEL				ARSS STANDS			
	LP-1	LP-2	LP-3	LP-6	SINGLE SIDED		DOUBLE SIDED	
					RAIL	BIN	RAIL	BIN
SB-1	24	32	48	96	15	135	30	270
SB-2	16	20	32	64	12	108	24	216
SB-3	9	12	18	36	9	63	18	126
SB-4	6	8	12	24	14	35	28	70
SB-5	3	4	6	12	14	14	28	28
SB-6	6	8	12	24	14	35	28	70
ARTB-05	24	32	48	96	15	120	30	240
ARTB-10	24	32	48	96	12	96	24	192
ARTB-20	24	32	48	96	12	96	24	192
ARTB-25	9	12	18	36	8	48	16	96
ARTB-30	9	12	18	36	8	48	16	96
ARTB-40	4	6	8	18	12	24	24	48
ARTB-60	2	3	4	9	12	12	24	24
612-T	24	32	48	96	15	120	30	240
612-S	16	20	32	64	12	96	24	192
612-S2	16	20	32	64	12	96	24	192
612-M	6	8	12	24	9	45	18	90
612-DW	3	4	6	12	9	18	18	36
612-B	4	6	10	20	14	28	28	56
BULL BIN-5	16	20	32	64	12	108	24	216
BULL BIN-15	12	15	24	48	10	70	20	140
BULL BIN-25	9	12	18	36	9	54	18	108
BULL BIN-35	4	6	10	20	14	28	28	56
BULL BIN-45	4	6	8	16	10	20	20	40
AKP-01	24	32	48	96	15	120	30	240
AKP-11	16	20	32	64	12	96	24	192
AKP-22	9	12	18	36	16	48	32	96
AKP-32	9	12	18	36	16	48	32	96
AKP-33	6	8	12	24	16	32	32	64
AKP-35	3	4	6	12	16	16	32	32

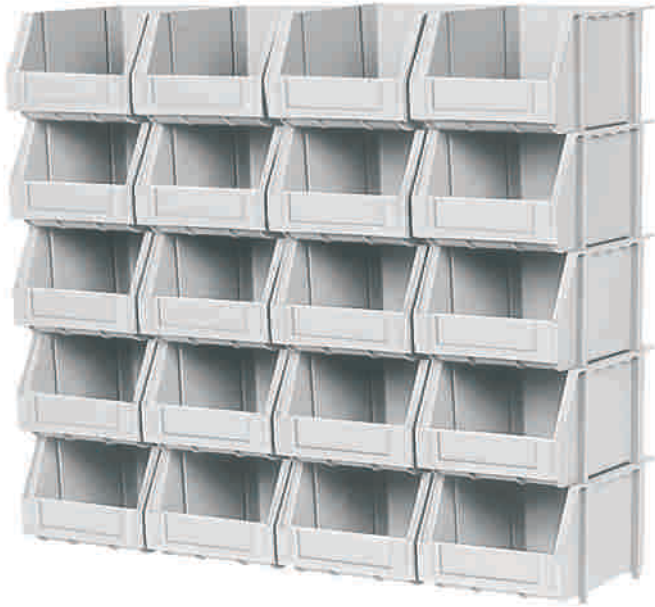
ALKON**POLY BINS & RAILS**

- ▶ Set of 20 Bins & 5 Rails.
- ▶ 5 Nos of Rails for wall Mounting.
- ▶ 20 Nos. of Bins can be stacked or mounted on Rails.
- ▶ Size of each POLY BIN 100mm x 75mm x 125 mm

Art No.: PBR-205

Bins fitted on rails

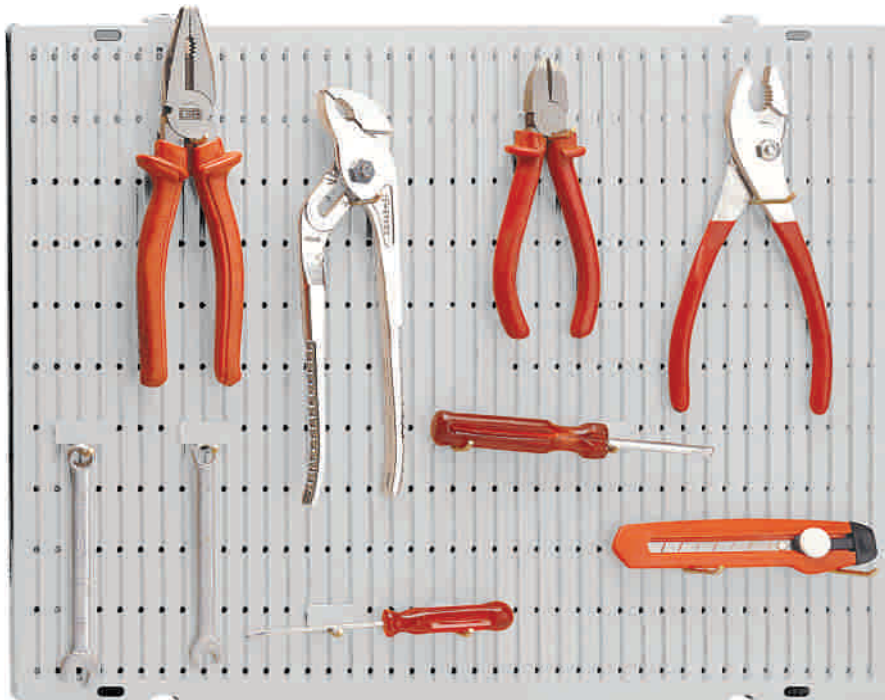
ORGANIZE**Small Parts, SCREWS, NUTS & MORE !****ALKON****MULTY DISPLAY BOARD**

- ▶ 451 hanging holes with 38 strong hooks of 2 sizes & 38 plastic locks.
- ▶ Extendable when necessary.
- ▶ For samples & other Displays.
- ▶ For retail outlets, offices, homes etc.
- ▶ Made of top quality plastic material.

Art No.: MDB-500**Size : 505 x 390mm**

Colours :

Red



Blue



Grey

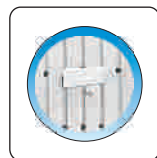
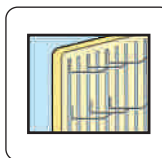
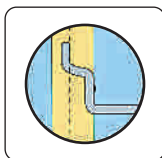

ALKON COMPONENT ORGANISERS



Art No. ACO 25

Ideal for storing electronic parts, hardware etc. Suitable for homes workshops and factories. Comes with clear see through plastic drawers for easy visibility of contents

Art No.: ACO 25 with 25 Drawers

Cabinet Size:
400mm x 250mm x 160mm

Size of drawers:
150mm x 75mm x 35mm.

ALKON USE ALL BOX

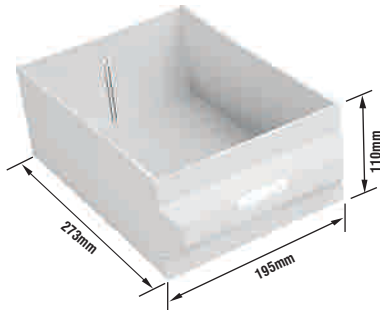

BIG DRAWER SIZE

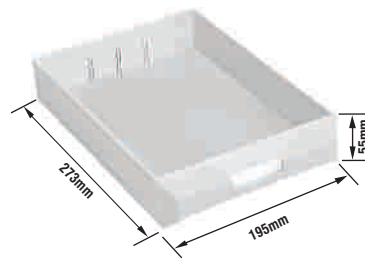

SMALL DRAWER SIZE

MULTIPURPOSE UTILITY BOX WITH ONE OR TWO DRAWERS

CABINET : Dark Grey colour
Size : 215mm x 282mm x 122mm

Drawers : Light Grey

Big Drawer : 195mm x 273mm x 110 mm
Small Drawer : 195mm x 273mm x 55 mm.

Multipurpose Utility box cabinet can be interlocked both vertically and horizontally.

Art No.: MUB-1 with one big drawer

Art No.: MUB-2 with two small drawer.



ASSEMBLY : LEFT TO RIGHT



ASSEMBLY : BOTTOM TO TOP

CONTAINER

Art No.: UC6

Size : 90mm x 95mm x 45 mm

6 Small containers can fit in one small drawer



CONTAINERS

VERTICAL PARTITION

Art No.: MUB-2 VP Vertical Partition.

Vertical Partition can fit in small drawers in the slots provided.

ALKON**TOOL TRAY**

TOOL TRAY

Multi Purpose Tool Tray

- ▶ For Screwdrivers, Files, Pliers, Spanners etc.
- ▶ Can be Screwed in walls, Workstations etc.
- ▶ Can be used on Louvre Panels

▶ Colours :

Red

Blue

Grey



Art No.: ATT

ALKON**SUPER DUST PAN**

- ▶ Rigid edge and wide mouth.
- ▶ Make Indoor / Outdoor chores quick & easy.
- ▶ The shovel handle snaps into broom and brush handle for convenient storage.
- ▶ Large size.
- ▶ 280 mm width in front.

Art No.: SDP - 1

Colours :

Red

Blue

Grey

Green

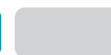



ALKON DRAWER CONTAINERS

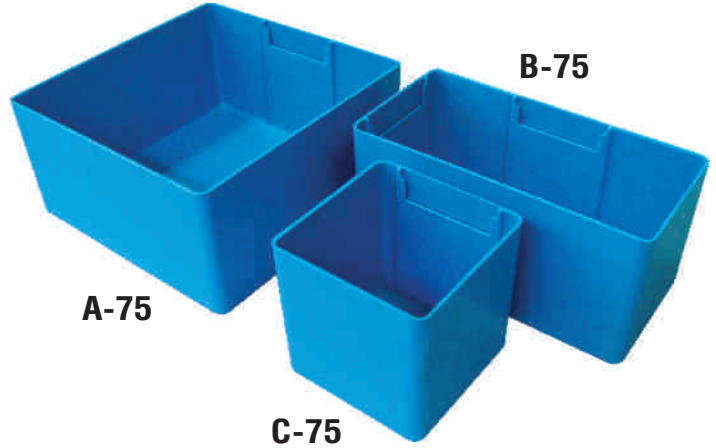
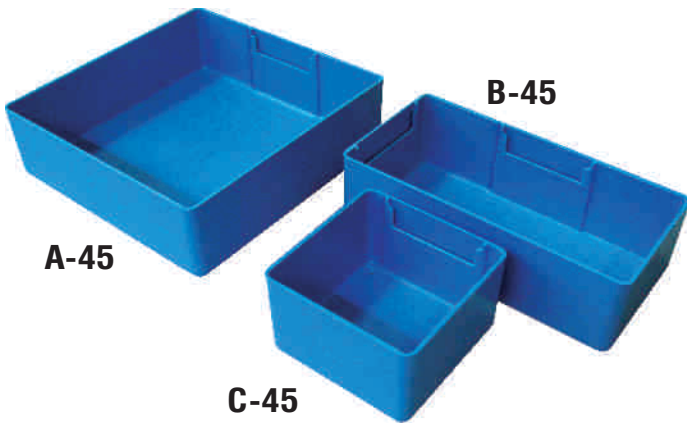

Made from High Impact Polystyrene, these drawer containers are ideal for storing hardware and standard parts inside drawers of tool cabinets

- ▶ These drawer containers are available in 6 sizes.
- ▶ These drawer containers when positioned, inside the standard tool cabinet drawers make easy and well defined compartments for each type of part stored in them.
- ▶ These drawer containers being modular help in organizing the drawers of tool cabinets to store different parts very easy.
- ▶ Each Container has a label holder which permit the insertion of labels for easy part identification.
- ▶ These containers are individually removable if required in the drawer.
- ▶ These containers are available in blue colour only.

Container Dimensions

Art No.	Outside Dimensions in mm			Inside Dimensions in mm		
	Length	Width	Height	Length	Width	Height
A-45	150	150	45	144	144	42
B-45	150	75	45	144	70	42
C-45	75	75	45	70	70	42
A-75	150	150	75	144	144	72
B-75	150	75	75	144	70	72
C-75	75	75	75	70	70	72



Different combination of containers in use.

ALKON SLOTTED ANGLE FOOT PLATE

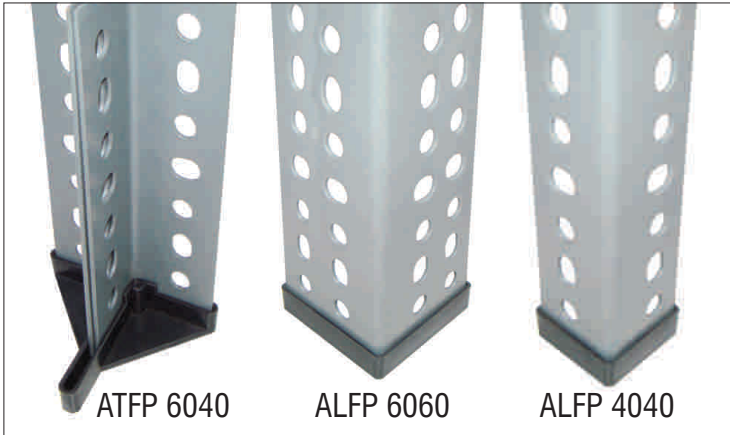

ATFP 6040

ALFP 6060

ALFP 4040

Slotted Angle Foot Plates are made from polypropylene copolymer.

Slotted Angle Foot Plates are available in three sizes :

‘T’ Foot Plate 60 mm x 40 mm

‘L’ Foot Plate 60 mm x 60 mm

‘L’ Foot Plate 40 mm x 40 mm

These sizes suit the standard slotted angles available in the market.

Standard colour available is BLACK.



ATFP 6040

ALFP 6060

ALFP 4040

Art No.	DISCRIPTION	STD. PACK
ATFP 6040	‘T’ Foot Plate 60 mm x 40 mm	500
ALFP 6060	‘L’ Foot Plate 60 mm x 60 mm	500
ALFP 4040	‘L’ Foot Plate 40 mm x 40 mm	500

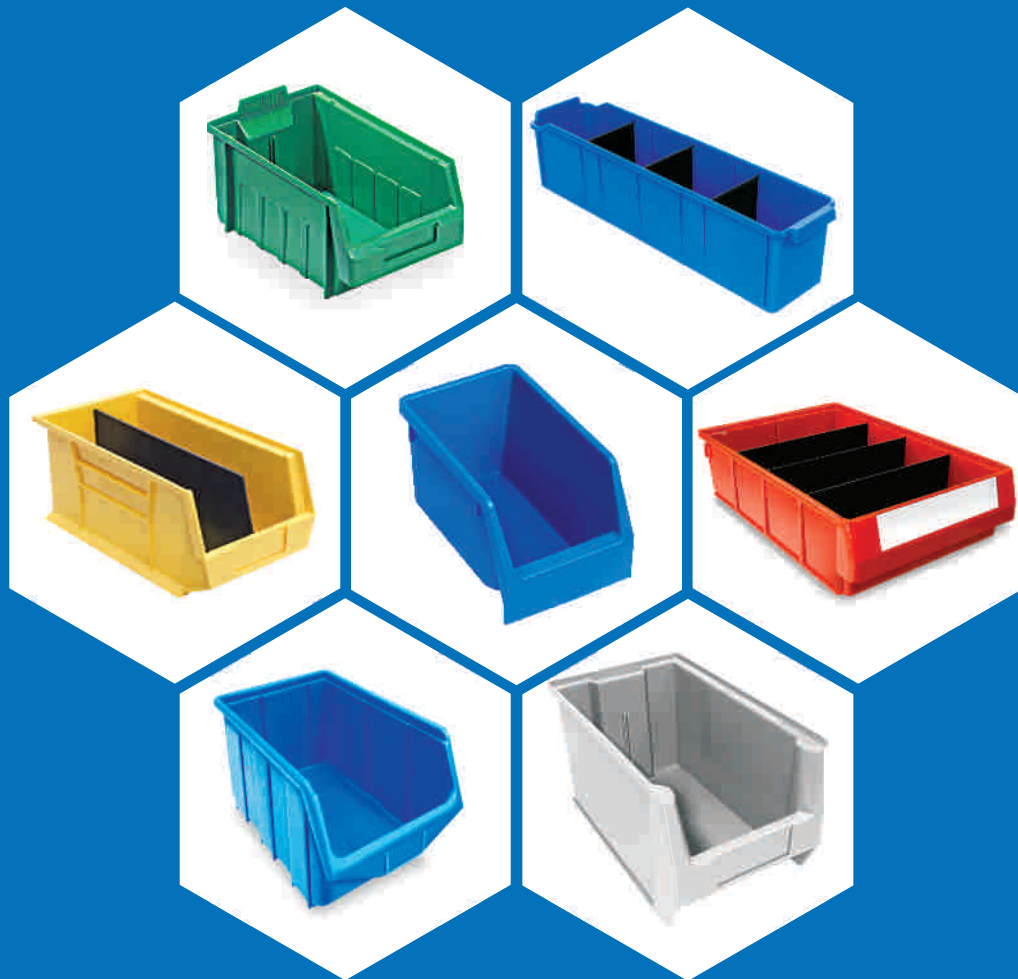

ALKON PLASTICS PVT. LTD.

Regd. Office :

801, Embassy Chamber, CTS No. E / 859 B-2,
3rd Road, Khar (W), Mumbai - 400 052, INDIA.
Tel.: 0091- 22- 2604 2168, 2604 7567, 2604 9165
Fax.: 0091- 22- 2605 1387
E mail : sales@alkonplastics.com

This Catalog should not be reproduced as it is covered under Copyright Act.

www.alkonplastics.com

STOCKIST

